



Application of Capacitor for Starting a Large 3 Phase Induction Motor in a Stand Alone Grid

Heramb Mayadeo, Milind Desale, Abhijit Satam and
Dinseh Junghare

EasyChair preprints are intended for rapid
dissemination of research results and are
integrated with the rest of EasyChair.

July 14, 2018

Application of Capacitor for Starting a Large 3 Phase Induction Motor in a Stand Alone Grid

A Case Study for a Cost Saving Alternative to Soft Starters

Heramb Mayadeo¹, Milind Desale², Abhijit Satam³, Dinesh Junghare⁴

Abstract— A standalone grid poses some quintessential and precarious problems of its own. One problem is the starting of large motors. While designing a standalone grid, a motor starting study is essential. This study is done to make sure the generator is capable of providing the starting reactive power required by the largest motor under the worst case. In one project, the generator in a standalone grid was incapable of delivering the required reactive power without increasing the generator rating. In that case, a variable frequency drive (VFD) starter was proposed to start the largest motor. This study investigates an alternative cost saving option for the same problem. The approach is to use capacitance during the motor starting. This compensates the starting reactive power requirements. This approach can be easily extended to micro grids, other standalone grids or captive generation. The study is performed using ETAP.

Keywords—Stand alone grid; microgrid; power system operation & control; ETAP; Captive Generation; Case Study

I. INTRODUCTION

More often than not, project requirements demand a standalone grid. Such grids can be encountered in ships, oil rigs and liquefied natural gas (LNG) terminals or even in micro grids. These grids typically have large induction motor loads. The ratings of these motors are comparable to that of generators. This poses quintessential problems from plant operation and control points of view. In one project, the generator in a standalone grid wasn't able to start the largest induction motor. Due to monetary requirements it became imperative to keep the generator the same size. After performing the study, a VFD starter was utilized as the starting solution. This starter is essentially a highly sophisticated V/f control. However, the VFD starter adds considerable cost.

Another approach to the problem is to use a capacitance connected to the motor terminals during the starting period. Shunt capacitor supplies the required reactive power during the motor starting period, which is otherwise lacking due to the poor starting power factor. The idea of using a capacitor bank to start an induction motor is not new. M. A. Badr, et al, proposed this idea in [2] but, his idea describes a method to start a three phase induction motor on a single phase supply. Similarly, the use of capacitors to start single phase induction motors is well documented [3], [4] but, the purpose of capacitors in single phase motors is to provide a spatial variation to a single phase supply and not current limiting or reactive power compensation. The approach of application of capacitors in motor starting stems from the use of capacitors in standalone induction generator systems [5], [6]. However, the capacitors are connected only during the starting in the former case and are constantly connected in the circuit in the later case.

This work mainly focuses on studying the feasibility of a shunt connected capacitor for motor starting and its techno-commercial comparison with VFD starting. The primary objective of this study is to provide a cost effective alternative for starting the largest induction motor without increasing the generator size. The study is performed using ETAP, on a practical case taken from one of the projects. For data confidentiality the parameters and other critical information are changed, keeping the essence of the problem the same.

The paper is organized in six sections, starting with the introduction in Section I. Section II speaks about the problem statement. It describes the problem formulation. In section III, the solution methodology is deliberated. Section IV contains the test case and simulation results. Section V forms the crux of the paper, it includes discussion on the results obtained. Section VI concludes the paper with remarks, observations and future scope.

II. PROBLEM FORMULATION

A. Description of the Grid

This peculiar problem was encountered during the auxiliary power system design of a gas turbine generator standalone grid. Figure 1 shows the single line diagram of the standalone grid under consideration. The system is divided into two medium voltage (MV) (11 kV) switchgear buses. Each bus has a separate generator of 17MW. This 11kV bus is connected to a 6.6kV bus through a transformer. A tie breaker is provided at both bus levels, 11 kV and 6.6 kV. Each 6.6 kV bus has a load of 7.5 MW. The operational idea is that in case one of the generators is out of service due to a planned or unplanned outage, the other generator will supply the bus connected to that generator through tie breaker arrangement.

The grid has large motor loads which are serving various fans, pumps and compressors. There are some lumped loads which represent the in-house consumption of the power plant including service supply and other in-plant requirements. The motors are all induction motors.

B. The Problem.

All the motors are started by a direct-on-line method of starting. For worst case scenario it is assumed that the largest motor, Mtr1, needs to be started directly on line when Generator 'Gen 2' is out of service and generator 'Gen 1' is supplying all the load. At the starting, the induction motor (Mtr1) has a very low power factor. This low power factor translates to high reactive power requirement. The generator is not able to handle this large reactive power requirement and hence the voltage at the motor terminals, generator bus and the MV supply bus drops beyond the acceptable limit. Initially, it

¹ Electrical Engineer, Power, Black & Veatch Private Limited, Pune, MayadeoH@bv.com

² Senior Electrical Engineer, Power, Black & Veatch Private Limited, Pune, DesaleM@bv.com

³ Lead Electrical Engineer, Power, Black & Veatch Private Limited, Pune, SatamA@bv.com

⁴ Lead Electrical Engineer, Power, Black & Veatch Private Limited, Pune, JunghareD@bv.com

was proposed that increasing the size of the generator would handle the requirement. Later, with vigorous study, it was observed that a VFD starter would be much cheaper than simply increasing the generator size just for the starting purpose.

This work investigates the technical and economic feasibility of shunt connected capacitors as an alternative to VFD or larger size generators.

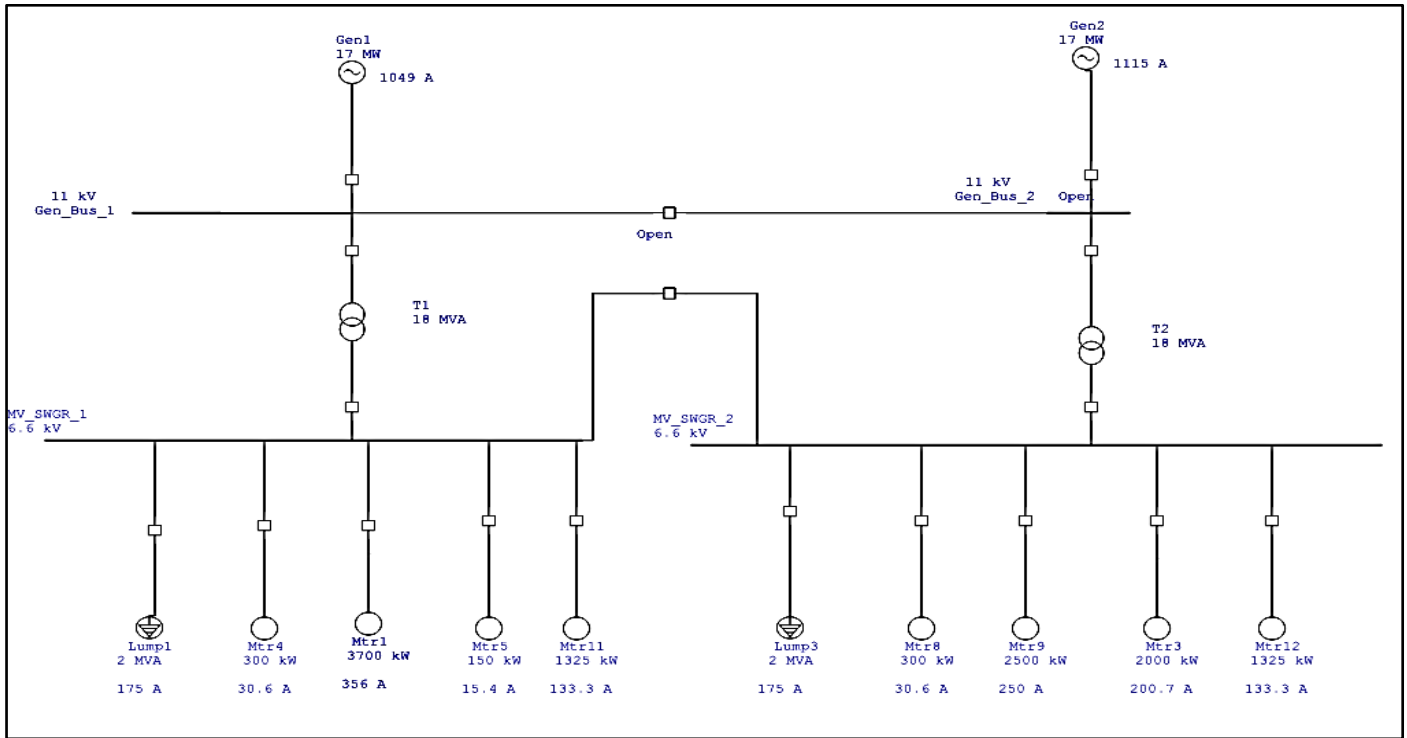

Figure 1 Single Line Diagram of the Standalone Grid

III. SOLUTION METHODOLOGY

Reduced voltage starting of an induction motor is a tried, tested and trusted method. For loads which do not require 100% torque at starting this method is a cheap and effective alternative. The only downside to this method is reduced torque at starting. Traditionally, star-delta starters, resistance in series starters, ballast choke in series starters are used to achieve the same [7]. The VFD starter which offers extremely sophisticated performance controls voltage as well as frequency to achieve maximum starting torque at reduced voltages. But, it needs high levels of control and includes additional cost of feedback and cabling. This section introduces an established VFD starting approach and proposed capacitor starting approach.

A. VFD starter

The most sophisticated and precise performance is offered by a VFD. VFD starter offers accurate control of the air gap flux by maintaining the voltage to frequency (v/f) ratio constant. Figure 2 shows the configuration of the system using VFD.

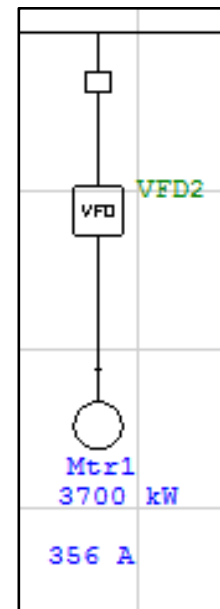

Figure 2 VFD Connected to the motor

B. Shunt capacitor at motor terminals.

This is the proposed approach over VFD starting.

Using a capacitor bank at the motor terminals for starting gives results comparable to the VFD. The capacitor bank is connected at the terminals of the motor and is taken off from the circuit after 1.5 seconds of the motor starting. The results are compared with direct on-line starting and VFD starting and their comparison is given in subsequent sections.

C. Reactive power required at starting.

Due to the addition of the capacitor bank at the motor terminals the motor bus observes a sudden increase in voltage for a short time. The magnitude of this voltage surge increases or decreases with the increase or decrease in the kVAR rating of the capacitor bank. Hence, kVAR rating shall be appropriately selected.

Ideally, the whole reactive power required by the motor at the start is to be compensated by the capacitor bank. But that raises the bus voltage at the starting beyond acceptable limits.

$$\frac{LR\ kVA}{HP} = 4.73 \tag{1}$$

$$HP_{Mtr1} = 4961 \tag{2}$$

$$kVA_{LR} = 23469 \tag{3}$$

$$PF_{start} = 19.47\% \tag{4}$$

$$kVA_{r_{LR}} = \sin(\cos^{-1}(0.1947)) \times 23469 = 23019 \tag{5}$$

Equation #5 gives the total locked rotor or starting kVAR required by the motor. If this value is used as the rating of the capacitor bank, the voltage at the motor terminals during switch off of the capacitor bank exceeds 170% of the rated voltage. This value is not acceptable. Hence, considering this as the ceiling value, the rating of the capacitor bank is decreased in steps of 1000 kVAR till the voltage surge comes within the acceptable limits.

After a step-by-step decrease of kVAR value, the final value of kVAR of the capacitor bank is fixed at 15000 kVAR. This value satisfies both the criteria mentioned above.

The case study and results are discussed in the subsequent section

IV. CASE STUDY & RESULTS

Three different cases are considered as follows,

- Base case
- VFD start
- Capacitor at the motor terminals

In all these cases the motor starting study is performed using ETAP. The variables observed in each case are,

- Motor current
- Speed
- Voltage at the motor terminals

A. Base Case

In this case no starting device is used. The results are as follows.

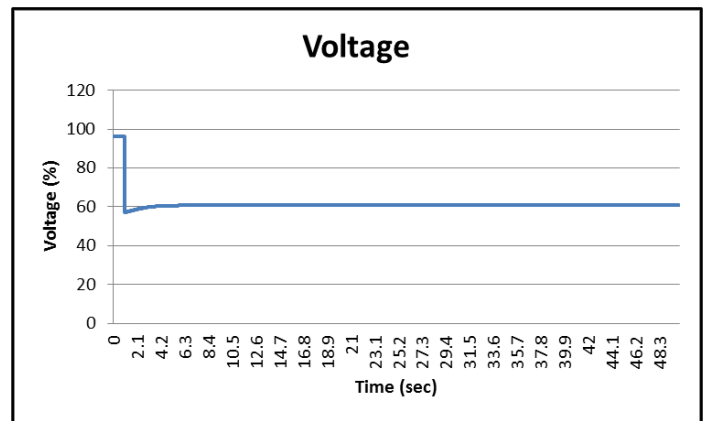
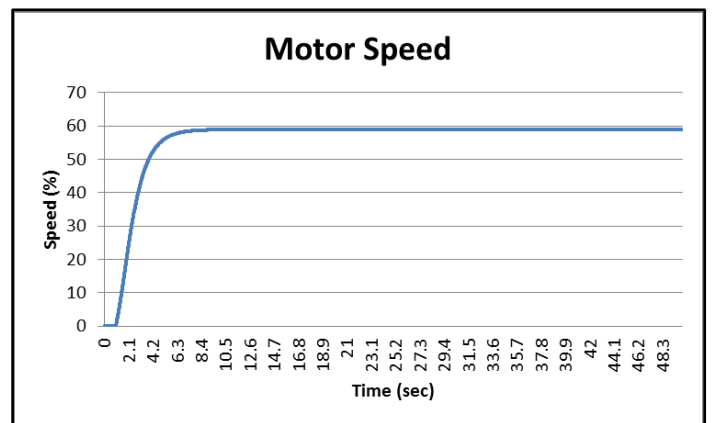
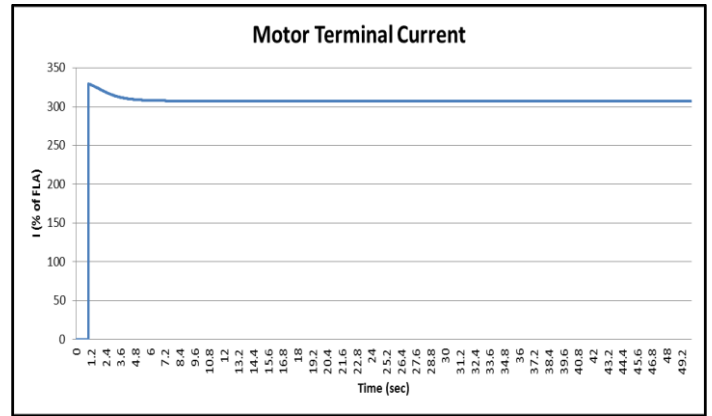

B. VFD start

In this case, motor is started using a VFD. This is the most sophisticated method and gives best performance.

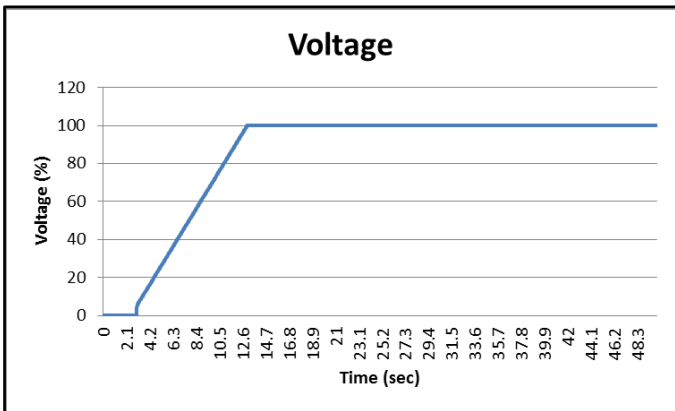
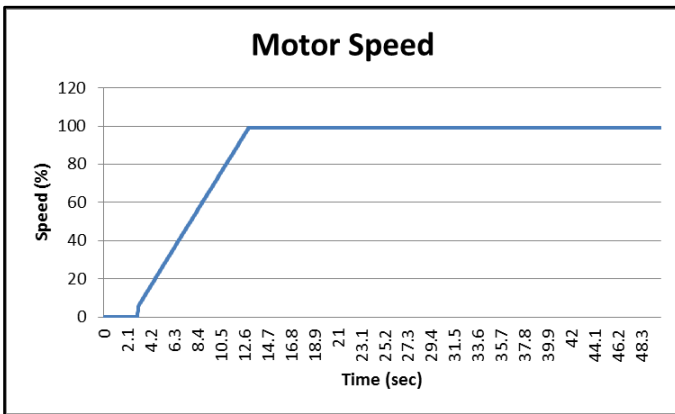
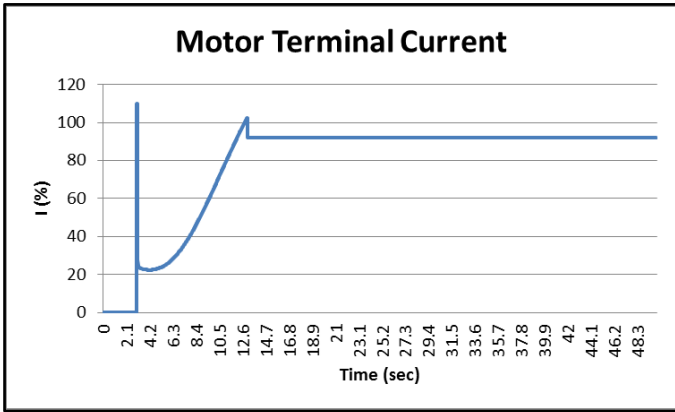

C. Capacitor at the terminals

In this case a capacitor bank is connected at the motor terminal. The rating is as calculated in section III.C.

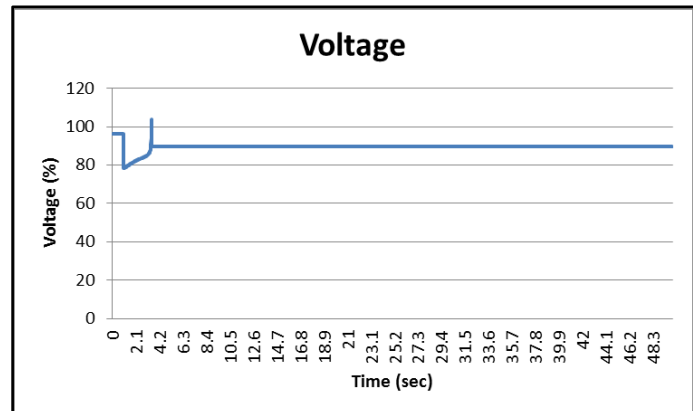
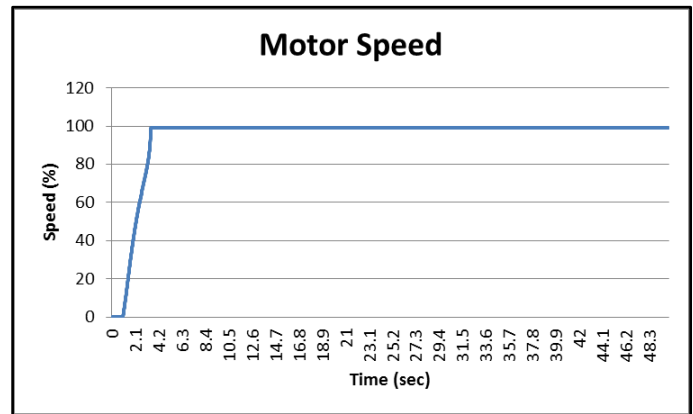
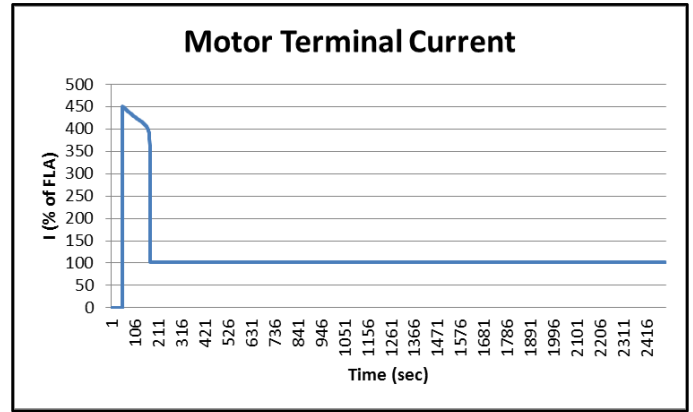

V. DISCUSSION

The results of the base case show that with the current size and capacity of generator it's not possible to start the motor when all the other loads are already running. The terminal voltage drops below 60% and the current drawn is approximately 250% which is not sufficient to generate the starting torque. The maximum speed attainable by the motor in this case is just under 60%.

In the case of the VFD starter, the best starting performance is achieved. The motor speed reaches from 0 to 100% in a smooth ramp fashion. The motor terminal current and the voltage at the motor terminals never exceed 100% mark.

The final case of capacitor starting gives a midway between direct online starting and VFD starting from a performance point of view. Though the motor terminal current at the starting reaches 450% of the full load current, the motor speed smoothly reaches 100% value from 0 in a ramp wise fashion. The terminal voltage at motor experiences an overvoltage. With a maximum value of 104% for duration of one second it is not a problem.

Table 1 gives the cost comparison of VFD and capacitor bank.

Table 1 Cost comparison of VFD vs Capacitor starting

	Capacitor Bank	VFD Starter
Approximate Cost in \$ (US)	2,85,040	7,01,728

Along with performance, the cost factor plays a vital role as well. The cost comparison, of each option, as given in Table 1 shows that the most viable option to start large motors, from a cost point of view, is a capacitor bank at the terminals.

VI. CONCLUSION

The technical performance comparison shows that a capacitor bank at the terminals of the motor gives acceptable results. Though a VFD can be used for multiple motors and gives best performance, a simple capacitor bank is equally acceptable. The cost comparison shows a drastic difference between the two options. The capacitor bank costs approximately 40% of that of a VFD. This is just the cost of the equipment. VFD will be added with the further cost of installation, commissioning and control accessories. These costs are comparatively less for a capacitor bank.

From the techno-commercial comparison it can be concluded, the motor can be started without violating safety limits at a much lesser cost.

ACKNOWLEDGMENT

The authors would like to thank Mr. Sudipta Samanta (Manager of Engineering, Black & Veatch Private Limited, Pune) and Mr. Satyen Kumar (Section Head, Electrical & Control, Black & Veatch Private Limited, Pune) for their

constant encouragement and support throughout this work. The authors would also like to express gratitude to Construction and Procurement team for providing costs of various pieces of equipment for making this work as realistic as possible.

REFERENCES

- [1] H. A. Toliyat and G. B. Kliman, *Handbook of Electric Motors*, Florida: CRC Press, Taylor & Francis Group, 2004.
- [2] M. Badr, A. I. Alolah and M. A. Abdel-Halim, "A Capacitor Start Three Phase Induction Motor," in *IEEE Transactions on Energy Conversion*, Portland, 1995.
- [3] I. Boldea and S. A. Nasar, *The Induction Mchine Handbook*, Florida: CRC Press LLC, 2002.
- [4] D. P. Kothari and I. J. Nagrath, *Electric Machines*, Delhi: Tata McGraw-Hill Education, 2004.
- [5] D. Levy, "Standalone induction generators," *Electric Power Systems Research*, vol. 41, no. 3, pp. 191-201, 1997.
- [6] B. K. Bose, *Power Electronics and Motor Drives*, Advances & Trends, ElsevierInc.,2006.
- [7] *Basics for Practical Operation Motor Starting*, Rockwell Automation Inc.,1998, pp. 1.9-1.10